

Test Report No. 7191039503-MEC13-04-DL
dated 8 Feb 2013



PSB Singapore

Choose certainty.
Add value.

Note: This report is issued subject to the Testing and Certification Regulations of the TÜV SÜD Group and the General Terms and Conditions of Business of TÜV SÜD PSB Pte Ltd. In addition, this report is governed by the terms set out within this report.

SUBJECT: Durability test of shower hinge.

TESTED FOR: CKS Glass Hardware Sdn Bhd (803232-H)
No. 37, Jalan Tembaga SD5/2G
Bandar Sri Damansara
52200 Kuala Lumpur, Malaysia
Tel: 603-6274 6599
Fax: 603-6275 8199

SAMPLE DESCRIPTION: Two pieces of shower hinges was received on 16 Jun 2012.
Two pieces of shower hinges is installed onto the door test-rig for test.
The shower hinges is described as follows:
Brand name: CKS
Model no: CKS-304 (glass to glass, 90°)
Material: Solid Brass
Finishing: Bright Chrome Plated

TECHNICAL DETAILS:

- 1) Self-closing function when door stays within 25 degree of opening
- 2) Suitable for 8 mm to 10 mm door thickness
- 3) Maximum door weight 45 kg per 2 hinges

METHOD OF TEST: Adopted from BS EN 1935: 2002
Building hardware – single axis hinges – Requirements and test methods
Clause 5.4 (Requirements) and Clause 7.5 (test method)

TEST SEQUENCE:

Clause 7.5 – Durability test

- 1) At 20 and 50,000 cycles - measure and record the torque required to initiate movement of the hinged leaf at operating angles of $0 \pm 5^\circ$, $30 \pm 5^\circ$, $60 \pm 5^\circ$ and $90^\circ \pm 5^\circ$.
- 2) At 20 and 50,000 cycles - measure and record the initial horizontal and vertical gaps between the hinged element and the datum surfaces.

DATE OF TEST: 3 Jan 2013

David Li
Associate Engineer

Ong Khay Beng
Engineer
Building
Mechanical Centre



Laboratory:
TUV SUD PSB Pte. Ltd.
No. 1 Science Park Drive
Singapore 118221

Phone : +65-6885 1333
Fax : +65-6776 8670
E-mail: testing@tuv-sud-psb.sg
www.tuv-sud-psb.sg
Co. Reg : 199002667R

Regional Head Office:
TUV SUD Asia Pacific Pte. Ltd.
3 Science Park Drive, #04-01/05
The Franklin, Singapore 118223
TUV®

TEST SAMPLE:

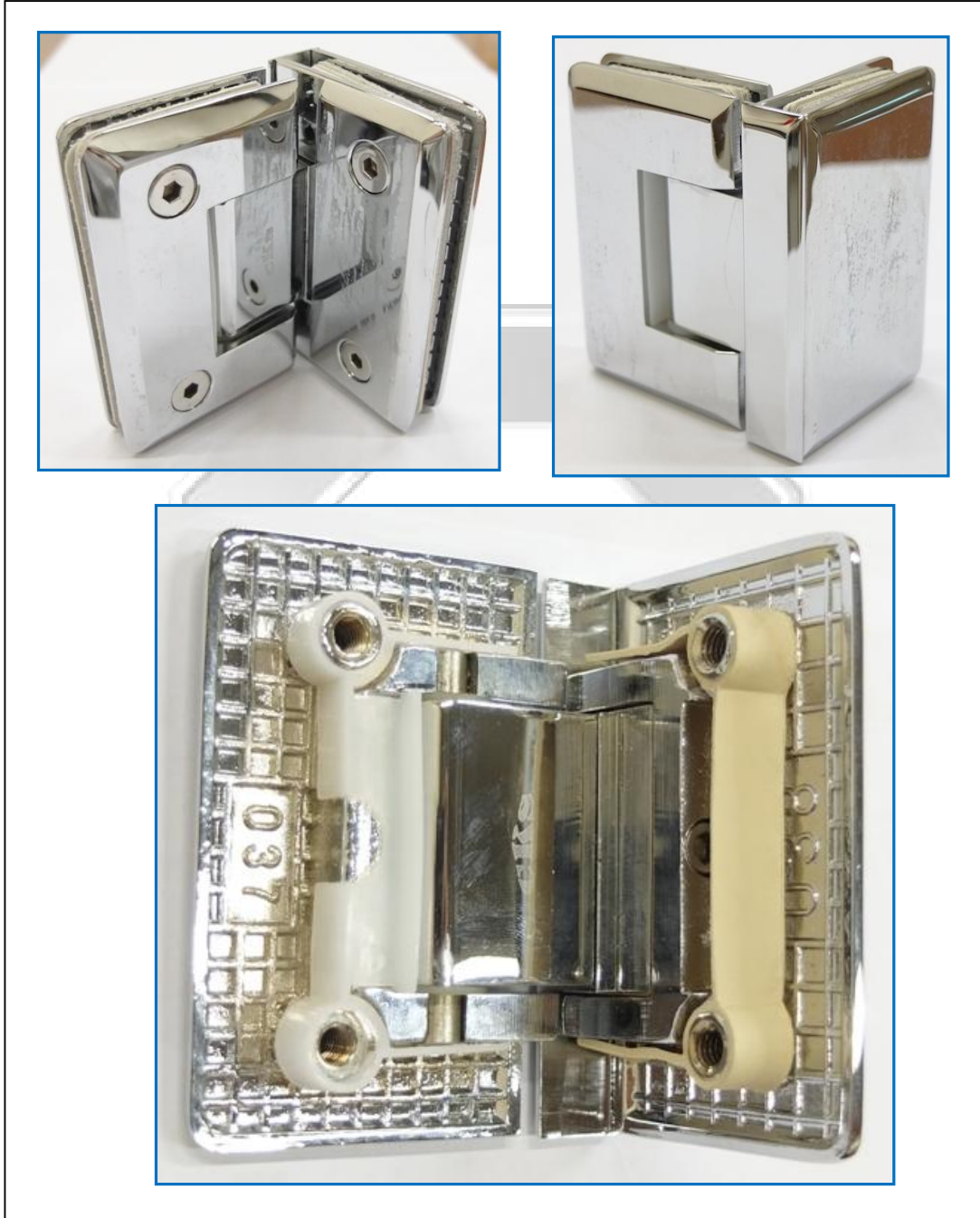

Figure 1: Shower hinge, model: CKS-304 (glass to glass, 90°)
(photo taken before test)





TEST RESULTS:

Date of test: 3 Jan 2013
 Door width: 750 mm
 Door weight: 45 kg
 Glass door thickness: 10 mm

The door used was design according to client's details as given.

1) Torque to initiate movement of the hinged leaf

Door opening	Torque measurement (Nm)	
	Initial at 20 cycles	After 50,000 cycles
0 +5°	2.9	2.2
30 ±5°	10.3	8.1
60 ±5°	5.9	7.4
90 ±5°	5.9	4.4

2) Measurement of horizontal and vertical gaps

	Initial at 20 cycles (mm)	After 50,000 cycles (mm)	Wear measurement (mm)	Results	BS EN 1935: 2002 Clause 5.4 (Requirements)
Horizontal gap	119.12	119.43	0.31	Passed up to 50,000 cycles.	The amounts of lateral and vertical wear of the hinge tested measured as displacements of the datum surfaces shall be within the shaded area as shown in Figure G.2
Vertical gap	183.02	183.44	0.42		

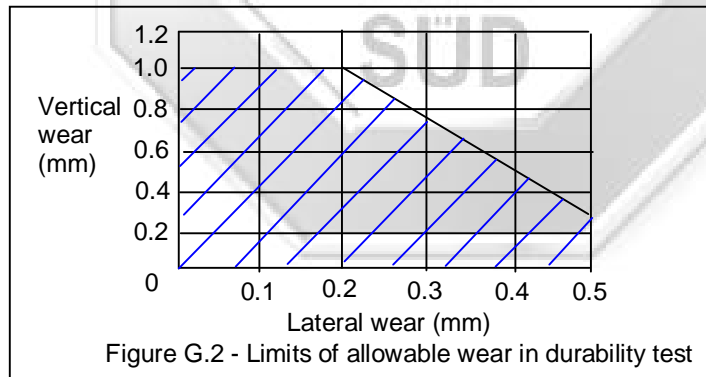

3) Self-closing functionality test

Test	Initial at 20 cycles	50,000 cycles	Company's Requirement
Self-closing function within 25 degree of opening	operable	operable	Self-closing function shall remains operable when door stays within 25 degree of opening.

Remarks: 1) Door was able to perform self-closing function up to 50,000 cycles.
 2) The horizontal & vertical wear maintain within specification up to 50,000 cycles.
 3) The shower hinge passed the endurance test up to 50,000 cycles.

TEST SET-UP:



Figure 2: Upper hinge under test
(close position)



Figure 3: Lower hinge under test
(close position)



Figure 5: Lower hinge under test
(open position)

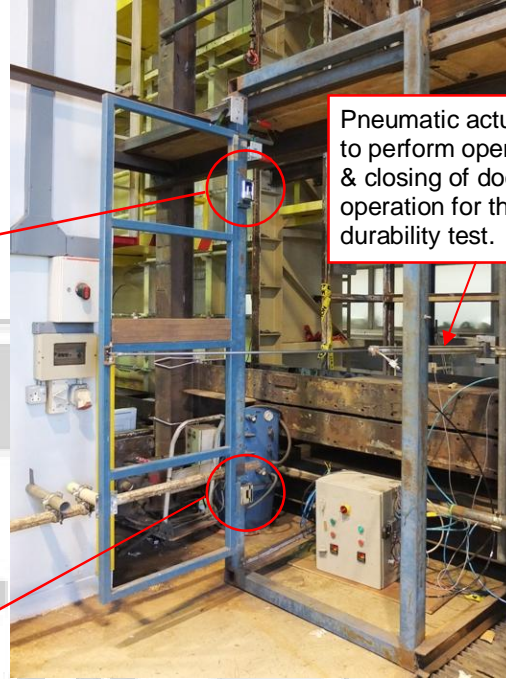

Pneumatic actuator
to perform opening
& closing of door
operation for the
durability test.

Figure 4: Door in close position



Figure 6: Door in open position (90°)



APPENDIX: PHOTO TAKEN AFTER TEST

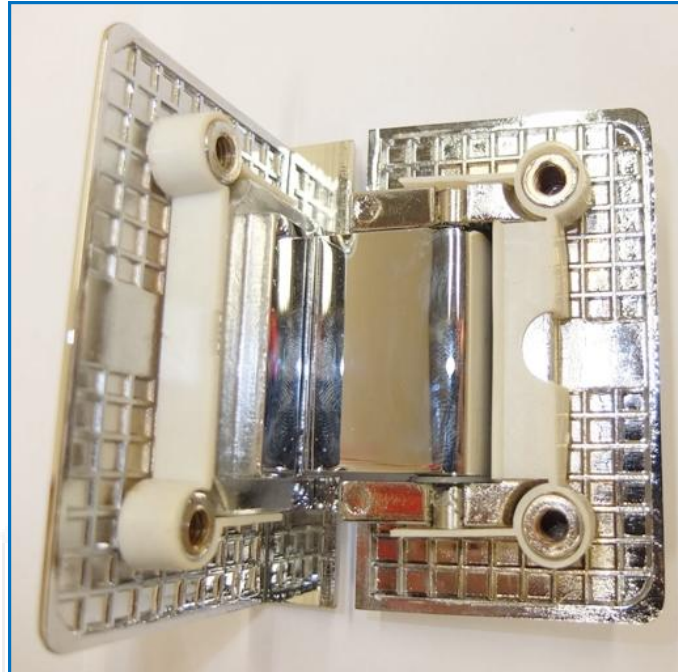

Figure 7: Upper hinge after 50,000 cycles of durability test

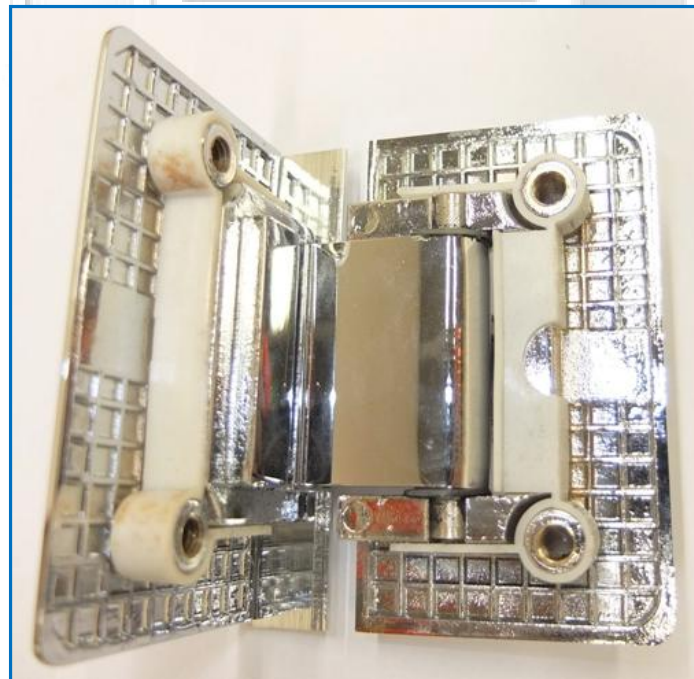
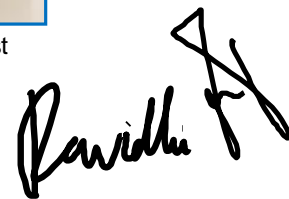
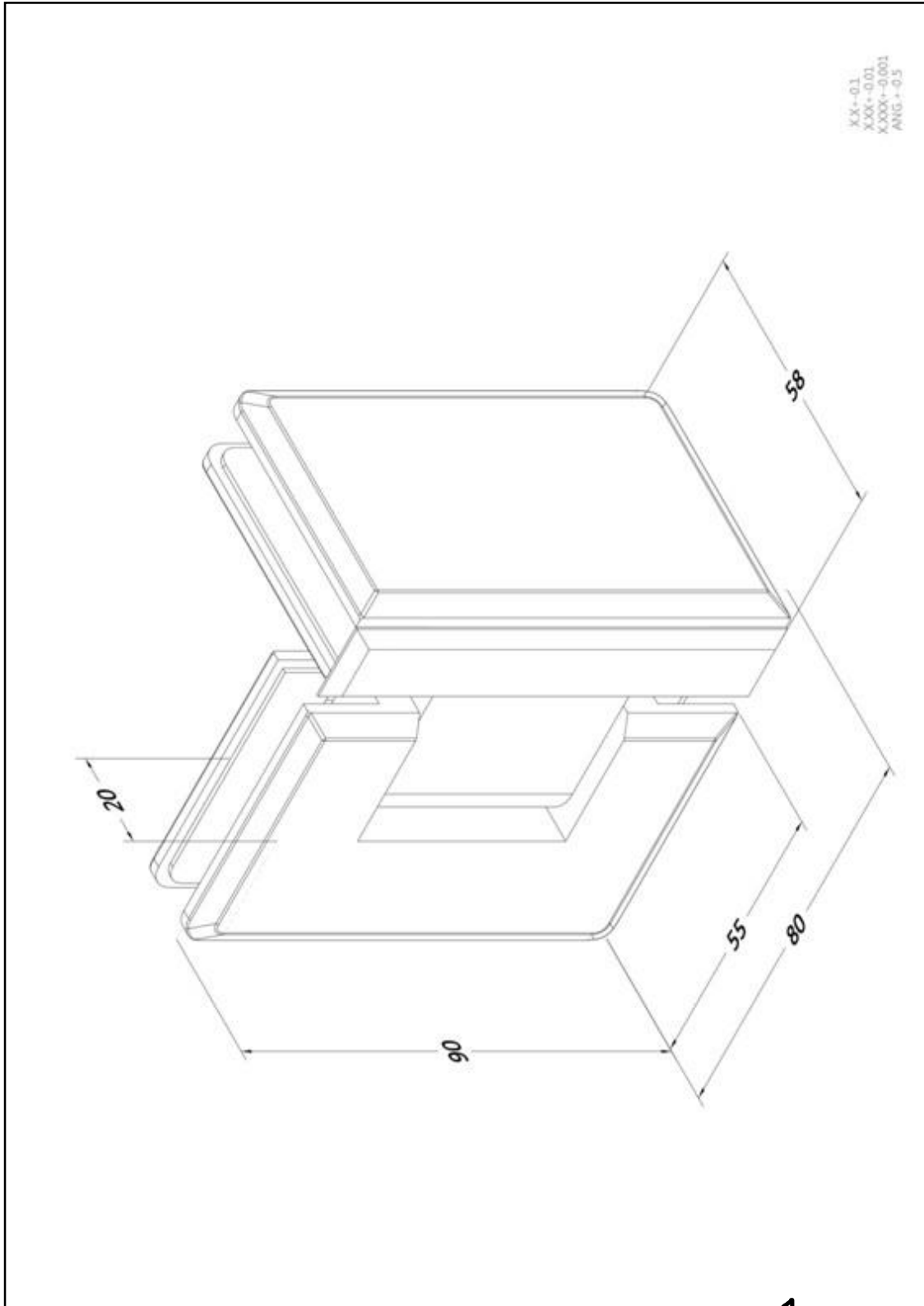

Figure 8: Lower hinge after 50,000 cycles of durability test





Shower hinge, model: CKS-304 (glass to glass, 90°)



SHOWER HINGES

• **CKS-301** Glass to wall

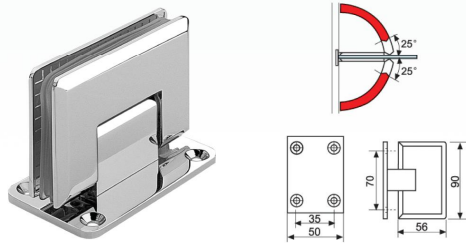

• **CKS-305** Glass to wall (offset)

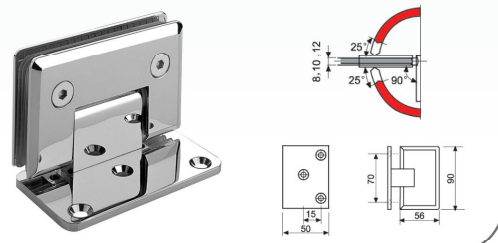

• **CKS-302** Glass to glass (135°)

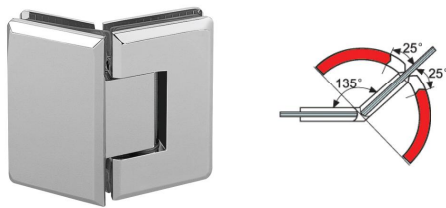

• **CKS-306** Glass to wall (fixed)

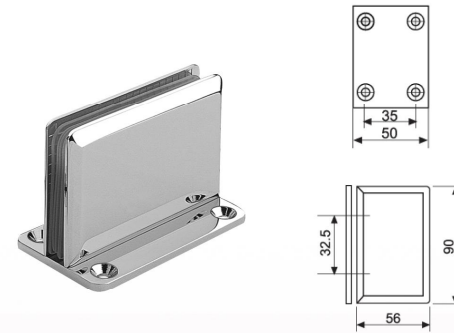

• **CKS-303** Glass to glass (180°)

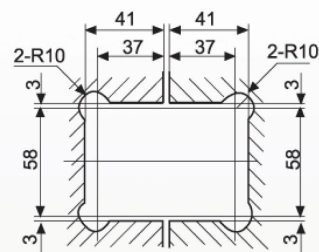
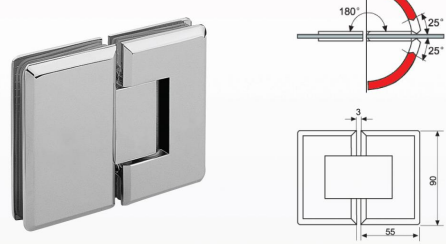

• **CKS-304** Glass to glass (90°)

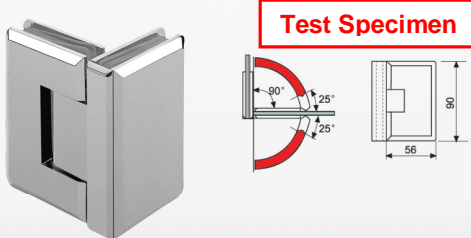

Self return from 25° (either direction)
Fit for door thickness: 8, 10mm
Door load up to 45kg
Material : Brass, Stainless Steel
Finish : Bright Chrome Plated (CP)
Polished Stainless Steel (PSS)
Satin Stainless Steel (SSS)

Glass preparation detail
(The glass angle of fixed panel need to cut 45°
when used in CKS 302 135° hinge)





Please note that this Report is issued under the following terms :

1. This report applies to the sample of the specific product/equipment given at the time of its testing/calibration. The results are not used to indicate or imply that they are applicable to other similar items. In addition, such results must not be used to indicate or imply that TÜV SÜD PSB approves, recommends or endorses the manufacturer, supplier or user of such product/equipment, or that TÜV SÜD PSB in any way "guarantees" the later performance of the product/equipment. Unless otherwise stated in this report, no tests were conducted to determine long term effects of using the specific product/equipment.
2. The sample/s mentioned in this report is/are submitted/supplied/manufactured by the Client. TÜV SÜD PSB therefore assumes no responsibility for the accuracy of information on the brand name, model number, origin of manufacture, consignment or any information supplied.
3. Nothing in this report shall be interpreted to mean that TÜV SÜD PSB has verified or ascertained any endorsement or marks from any other testing authority or bodies that may be found on that sample.
4. This report shall not be reproduced wholly or in parts and no reference shall be made by the Client to TÜV SÜD PSB or to the report or results furnished by TÜV SÜD PSB in any advertisements or sales promotion.
5. Unless otherwise stated, the tests were carried out in TÜV SÜD PSB Pte Ltd, No.1 Science Park Drive Singapore 118221.

July 2011

